

# SIRUBA®

銀爺牌工業用縫紉機

INDUSTRIAL SEWING MACHINE





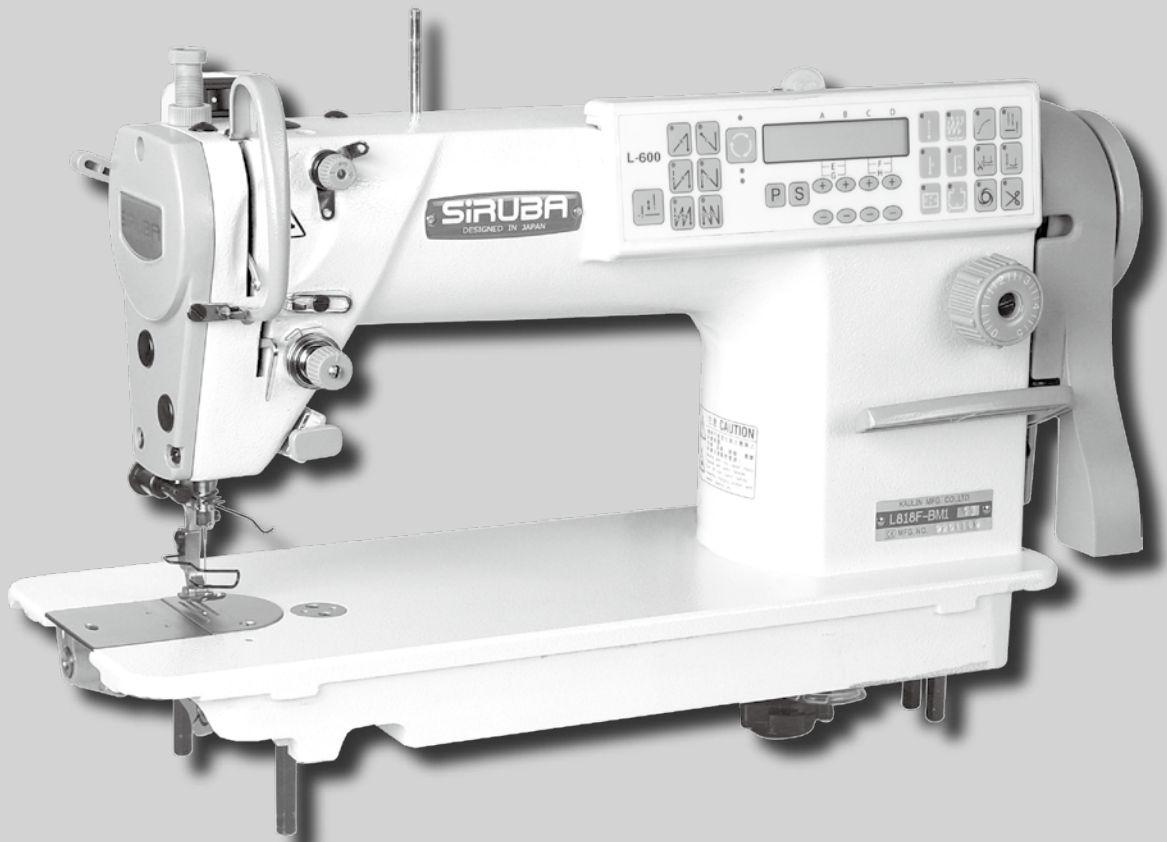

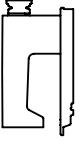

# L818F-BH1/BM1

## 零件圖 PARÇA LİSTESİ

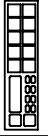

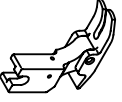
高林股份有限公司  
KAULIN MFG. CO., LTD.

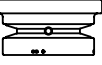

										
MODEL	SUB-CLASS	OPERATING PANEL	NEEDLE PLATE	FEED DOG	PRESSER FOOT	HOOK ASM	BOBBIN CASE ASM	BOBBIN	NEEDLE	HAND WHEEL
機型	規格	操作盒	針板	送具	押具	梭頭	梭殼	梭子	針號	皮帶輪
L818F-BM1-00 L818F-BM1-03 L818F-BM1-10 L818F-BM1-13	中厚布料	LA55F-A [H] L600	E704 E704	D701 D701	P701 P701	G121 G121	G202 G202	G303 G303	DB*1#14 DB*1#14	GLH101-A1 GLH101-A1
L818F-BH1-00 L818F-BH1-03 L818F-BH1-10 L818F-BH1-13	中厚布料 至 厚布料	LA55F-A [H] L600	E711 E711	D711 D711	P711 P711	G125 G125	G202 G202	G303 G303	DB*1#21 DB*1#21	GLH101-A1 GLH101-A1
L818F-BM1A-00 L818F-BM1A-03 L818F-BM1A-10 L818F-BM1A-13	中厚布料	LA55F-A [H] L600	E704D E704D	D702 D702	P701 P701	G121 G121	G202 G202	G303 G303	DB*1#14 DB*1#14	GLH101-A1 GLH101-A1
L818F-BH1A-00 L818F-BH1A-03 L818F-BH1A-10 L818F-BH1A-13	中厚布料 至 厚布料	LA55F-A [H] L600	E711D E711D	D711D D711D	P711D P711D	G125 G125	G202 G202	G303 G303	DB*1#21 DB*1#21	GLH101-A1 GLH101-A1

# 規格件表 DONUSTURME SEMASI

										
MODEL	SUB-CLASS	OPERATING PANEL	NEEDLE PLATE	FEED DOG	PRESSER FOOT	HOOK ASM	BOBBIN CASE ASM	BOBBIN	NEEDLE	HAND WHEEL
機 型	規 格	操作盒	針 板	送 具	押 具	梭 頭	梭 殼	梭 子	針 號	皮 帶 輪
L818F-BHM1A-01	薄中布 至 厚布料	LA55F-A	E704D	D702	P701	G122	G202	G303	DB*1#14	GLH101-A1
L818F-BHM1A-02		LA55F-A	E704D	D702	P701	G122	G202	G303	DB*1#14	GLH101-A1
L818F-BHM1A-11		<input type="checkbox"/> L600	E704D	D702	P701	G122	G202	G303	DB*1#14	GLH101-A1
L818F-BHM1A-13		<input type="checkbox"/> L600	E704D	D702	P701	G122	G202	G303	DB*1#14	GLH101-A1
L818F-BHM1-00	薄中布 至 厚布料	LA55F-A	E704	D701	P701	G122	G202	G303	DB*1#14	GLH101-A1
L818F-BHM1-01		LA55F-A	E704	D701	P701	G122	G202	G303	DB*1#14	GLH101-A1
L818F-BHM1-02		LA55F-A	E704	D701	P701	G122	G202	G303	DB*1#14	GLH101-A1
L818F-BHM1-11	厚布料	<input type="checkbox"/> L600	E704	D701	P701	G122	G202	G303	DB*1#14	GLH101-A1
L818F-BHM1-13		<input type="checkbox"/> L600	E704	D701	P701	G122	G202	G303	DB*1#14	GLH101-A1

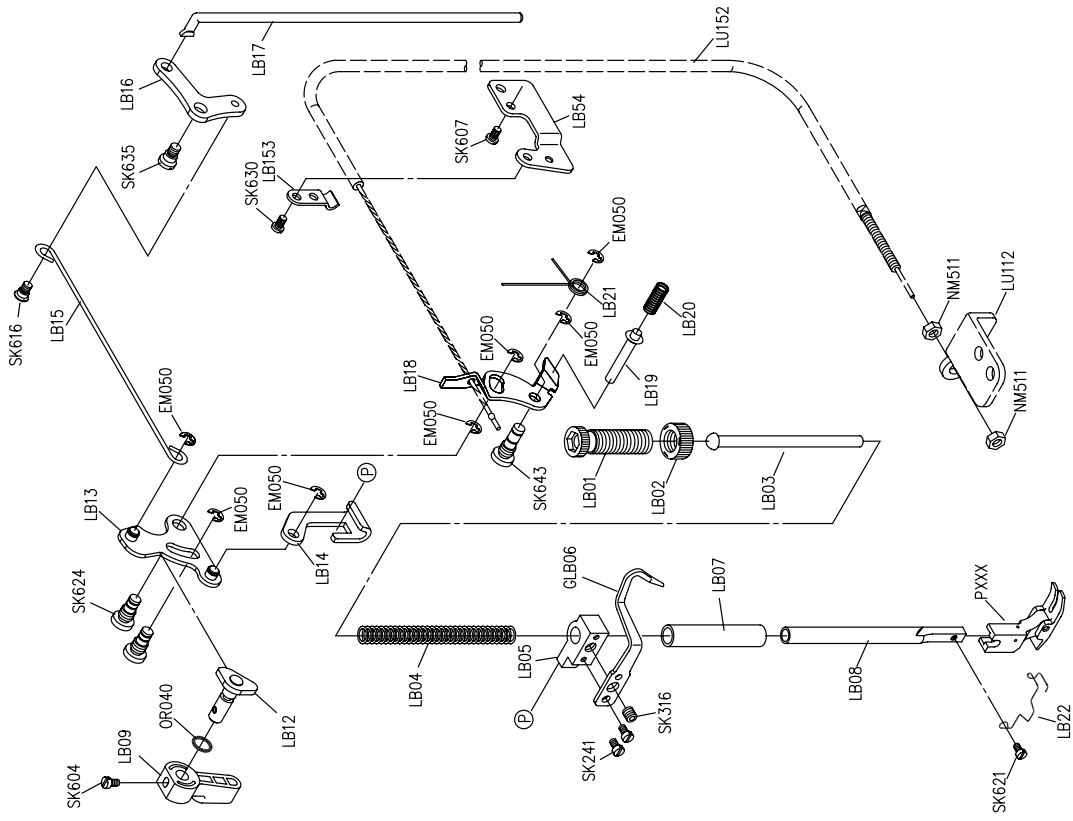

## LB GRUP İÇİN PARÇA LİSTESİ

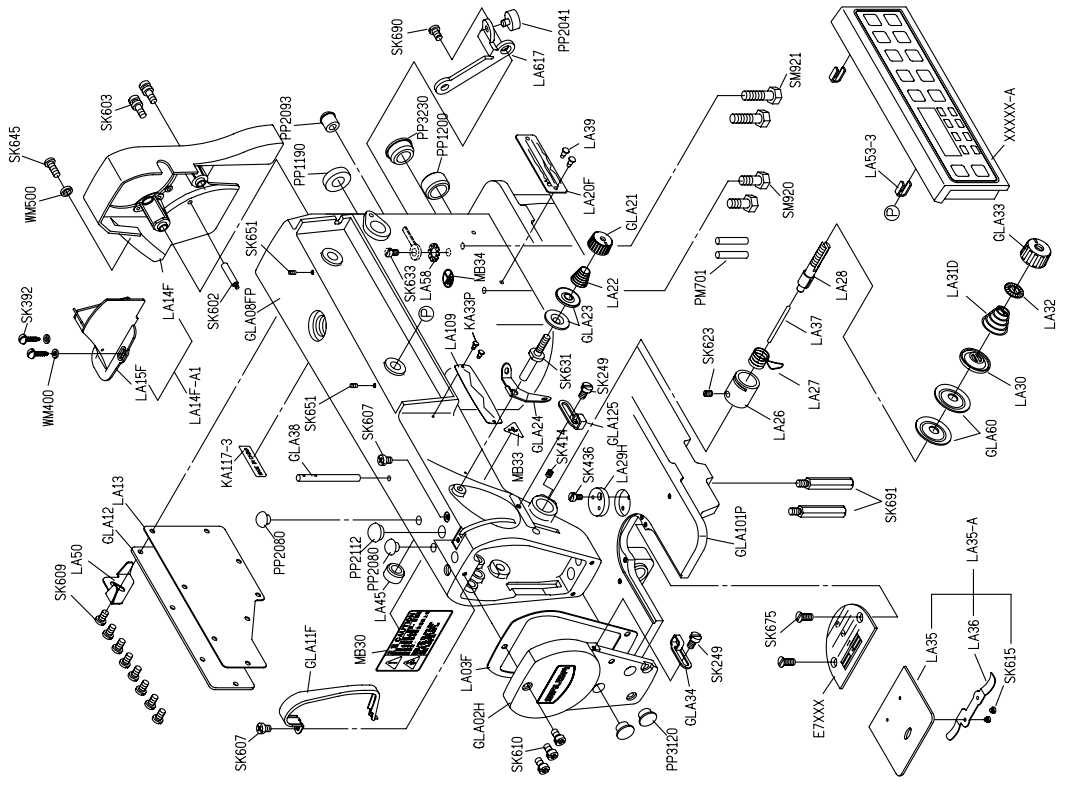

## LA GRUP İÇİN PARÇA LİSTESİ

# LC GRUP İÇİN PARÇA LİSTESİ

# LD GRUP İÇİN PARÇA LİSTESİ

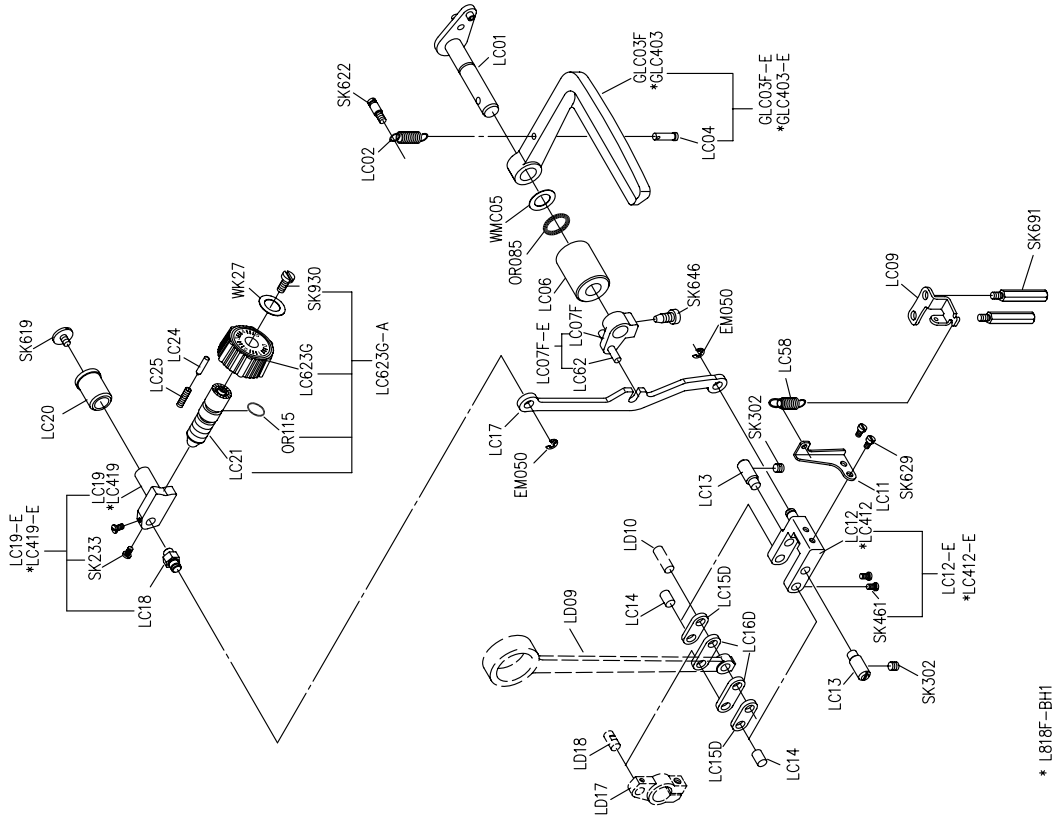

\* L818F-BH1

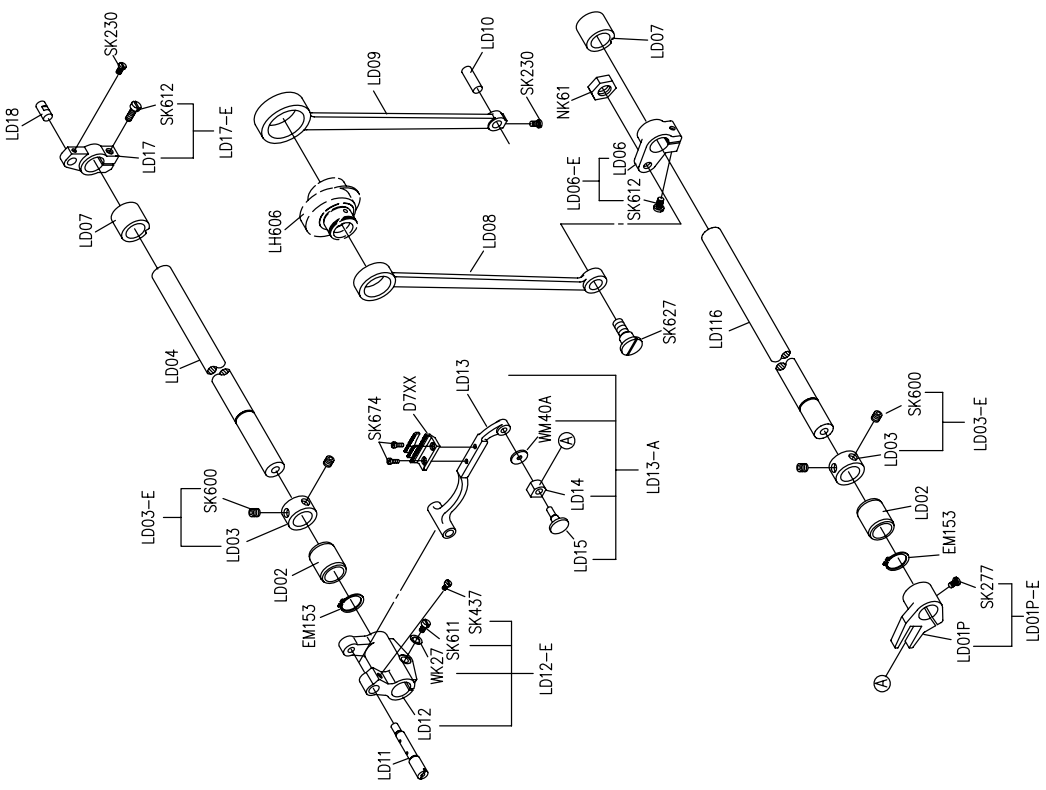

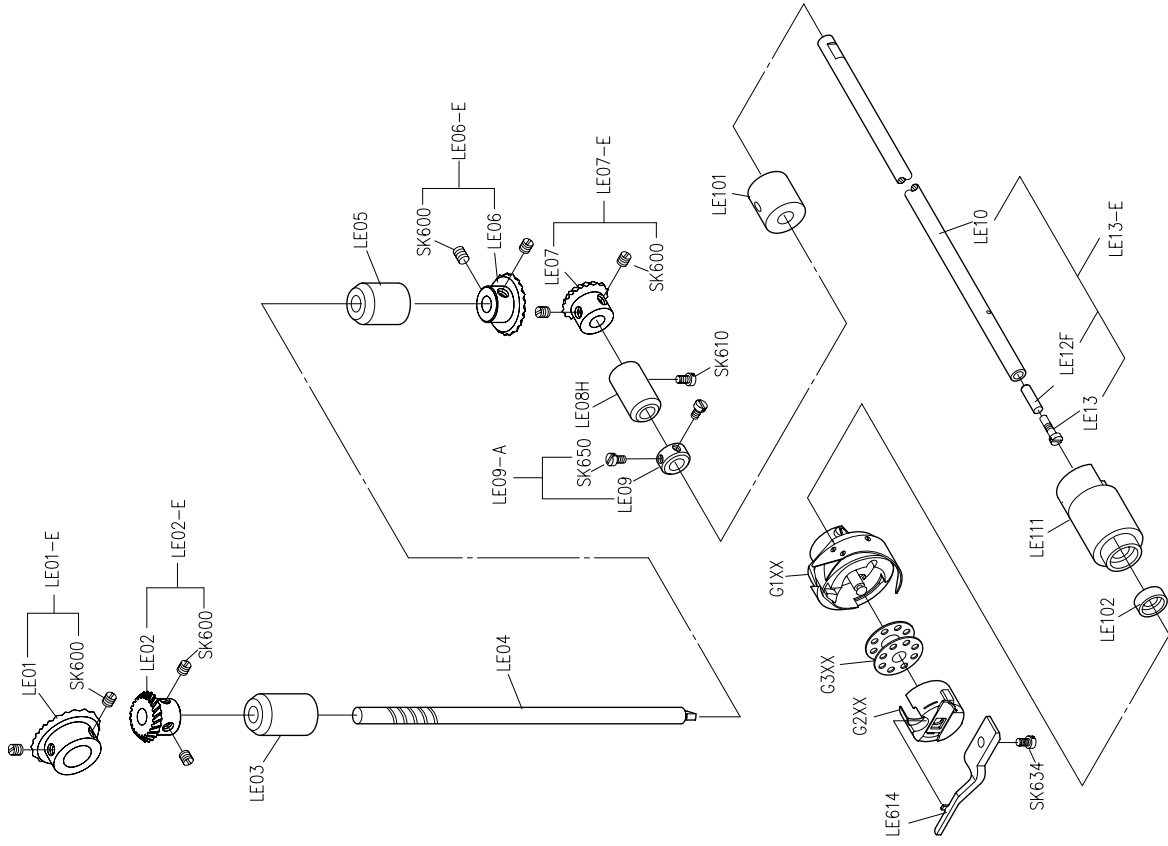

## LE GRUP İÇİN PARÇA LİSTESİ

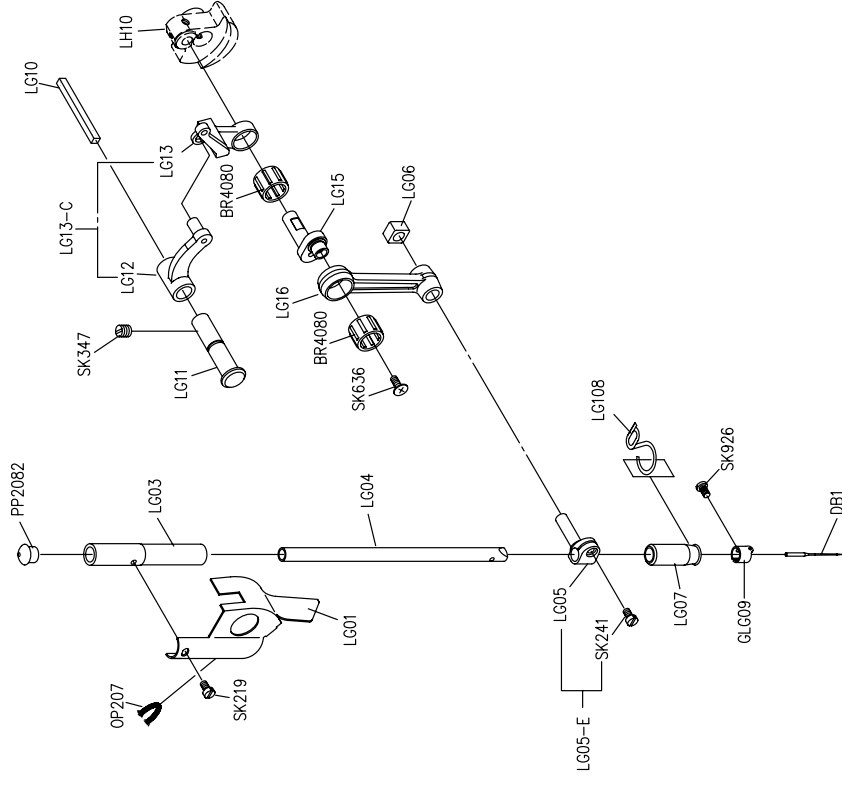

## LG GRUP İÇİN PARÇA LİSTESİ

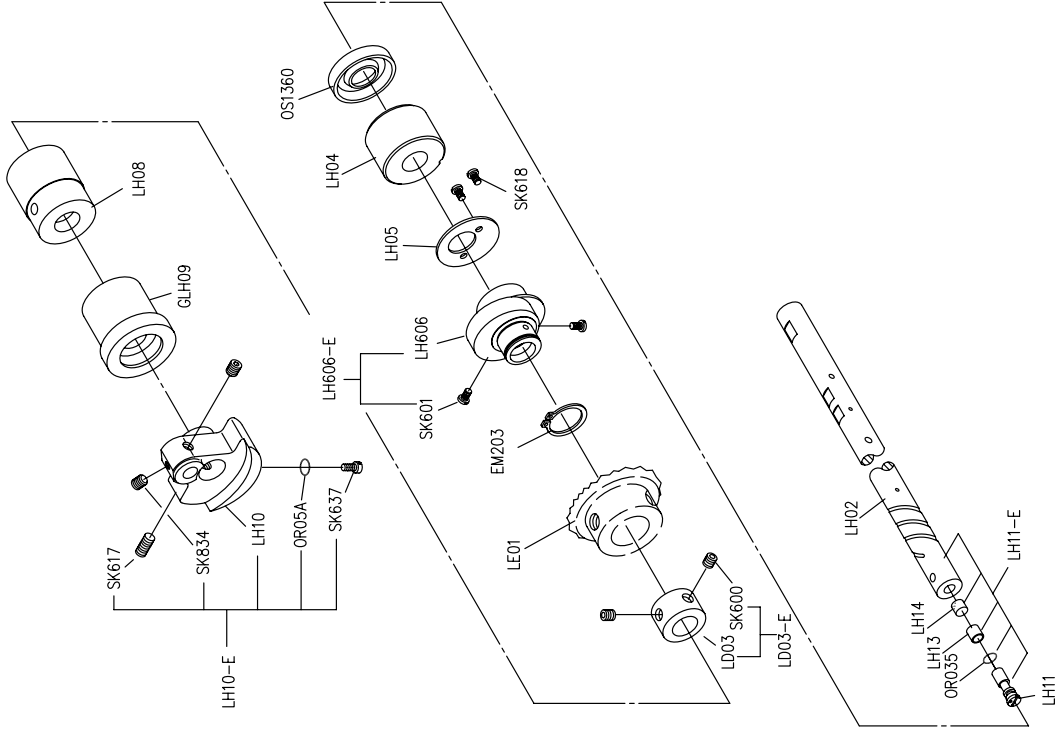

廠牌馬達	擺動式切刀	旋轉式切刀
H 廠牌馬達	<p>GLH01-A1</p>	<p>GLH101-A1</p>
其他廠牌馬達(可加後拉輪)	<p>GLH01-E</p>	<p>GLH101-E</p>
P 廠牌馬達	<p>GLH01P-A</p>	<p>GLH101P-A</p>
P 廠牌馬達(可加後拉輪)	<p>GLH01P-A</p>	<p>GLH101P-A</p>



LM01H-A

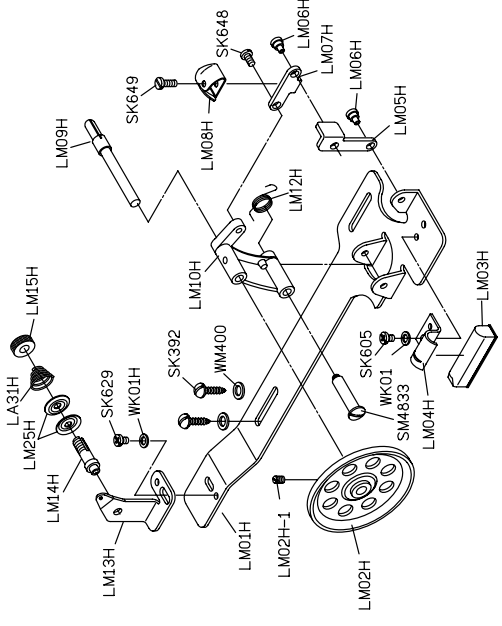

LM24-E

LM20-A

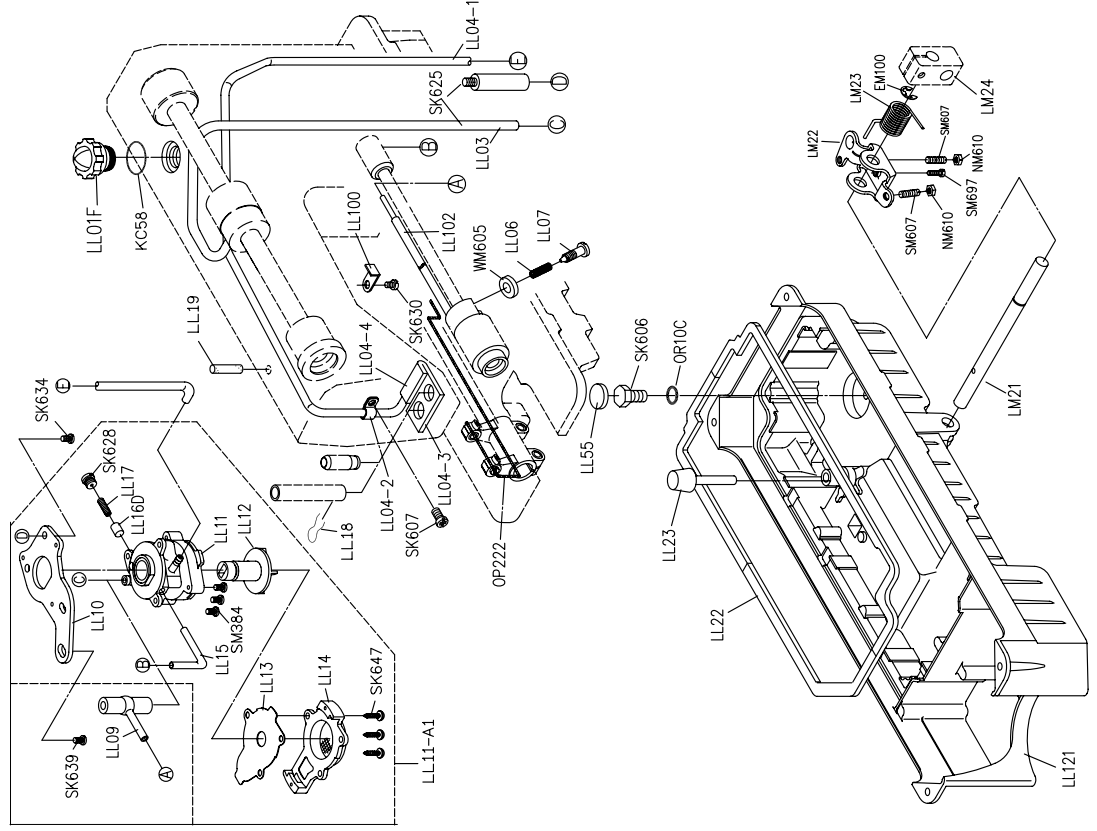
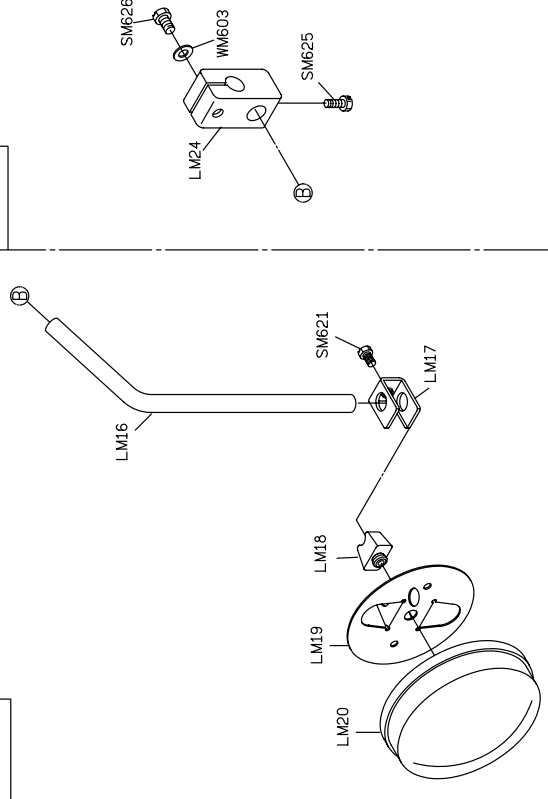

# LL GRUP İÇİN PARÇA LİSTESİ

# LM GRUP İÇİN PARÇA LİSTESİ



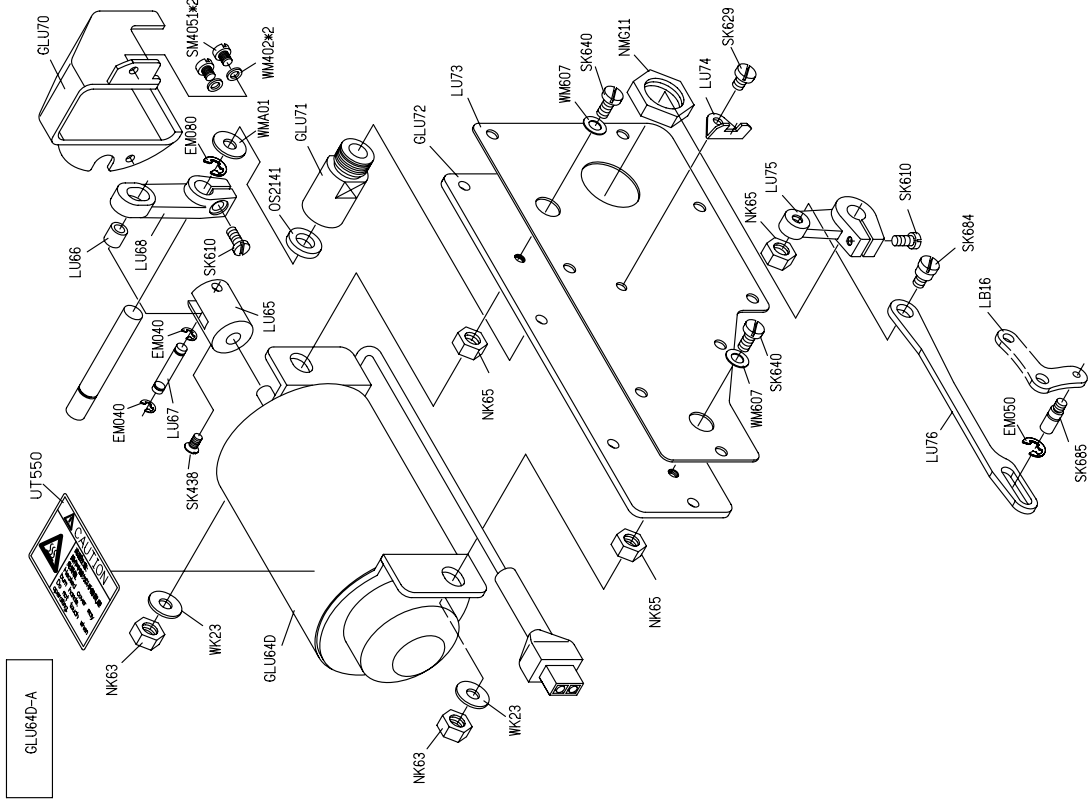

GLU64D-A

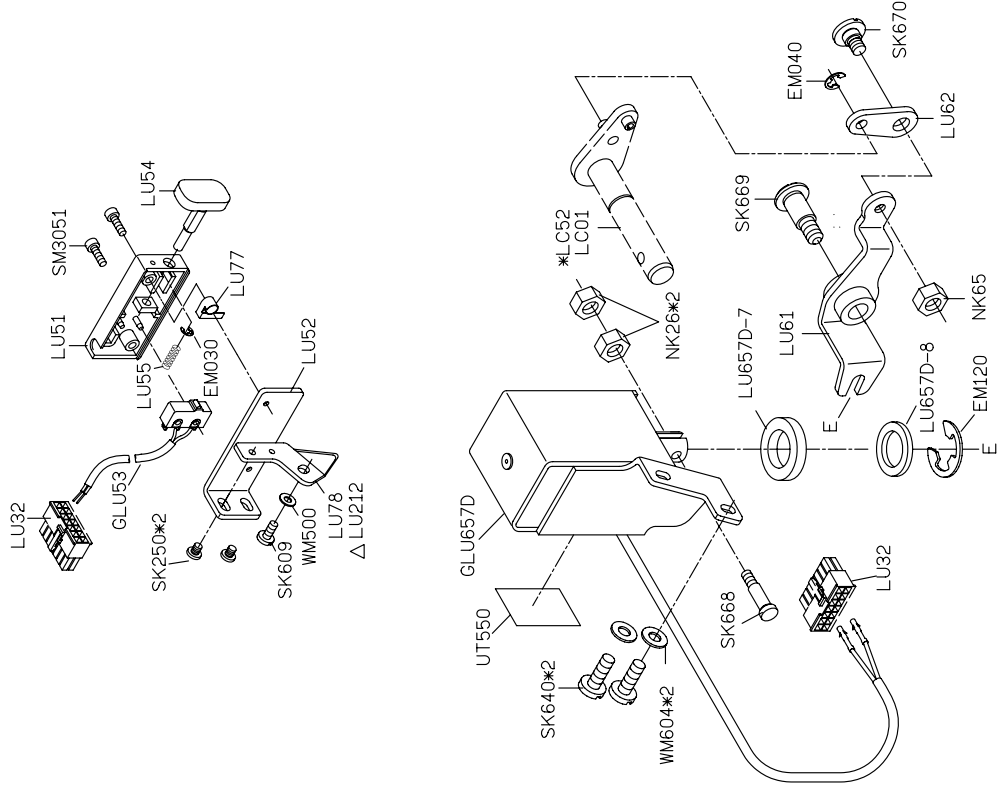

LU GRUP İÇİN PARÇA LİSTESİ

LU GRUP İÇİN PARÇA LİSTESİ

# LU GRUP İÇİN PARÇA LİSTESİ

# LY GRUP İÇİN PARÇA LİSTESİ

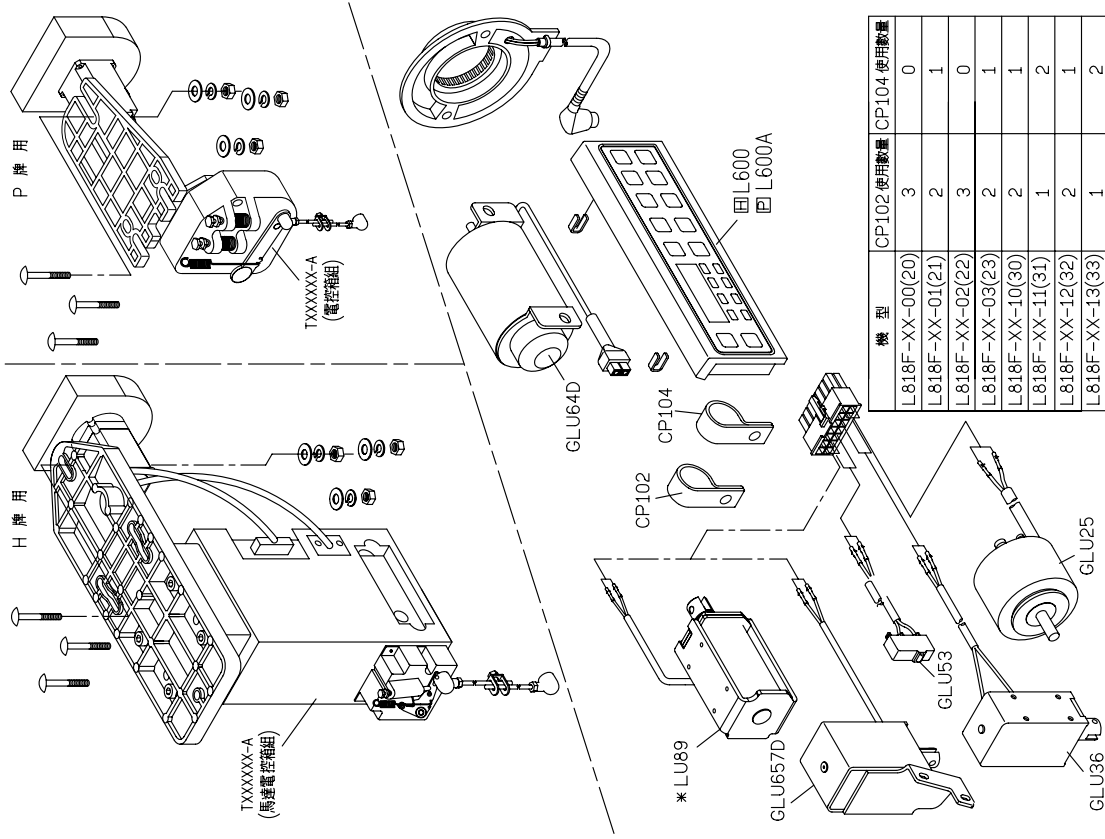

機 型	CP102 使用數量	CP104 使用數量
L818F-XX-00(20)	3	0
L818F-XX-01(21)	2	1
L818F-XX-02(22)	3	0
L818F-XX-03(23)	2	1
L818F-XX-10(30)	2	1
L818F-XX-11(31)	1	2
L818F-XX-12(32)	2	1
L818F-XX-13(33)	1	2

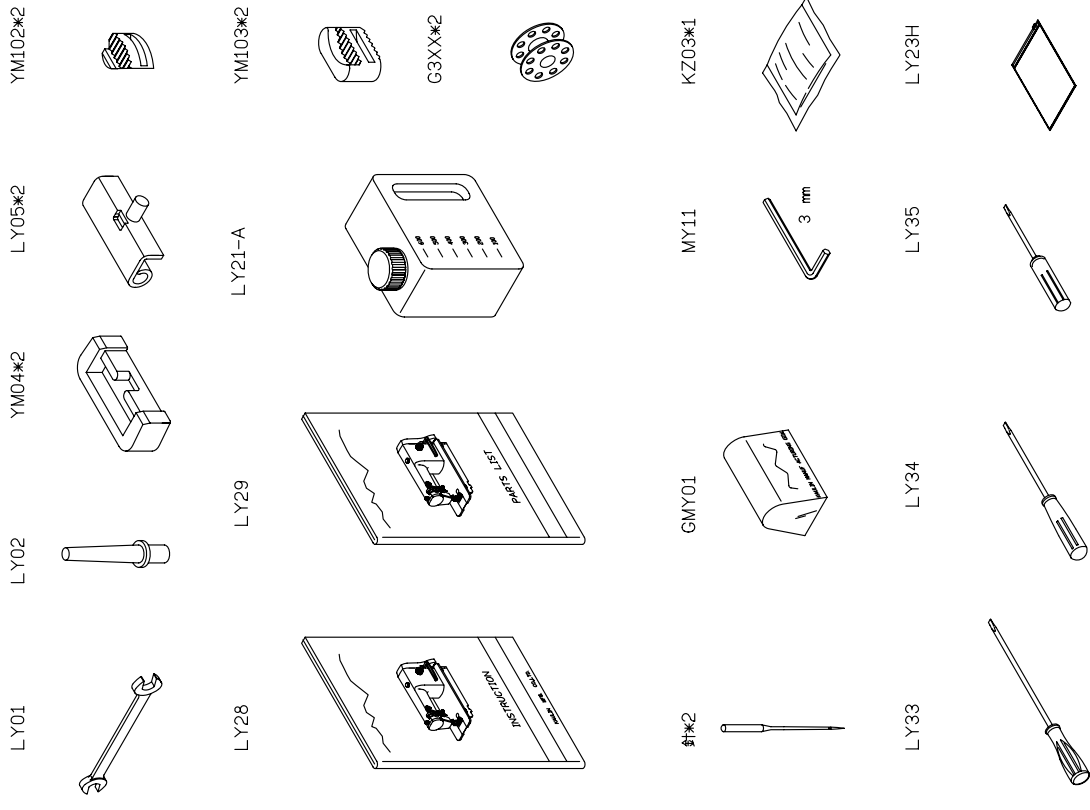

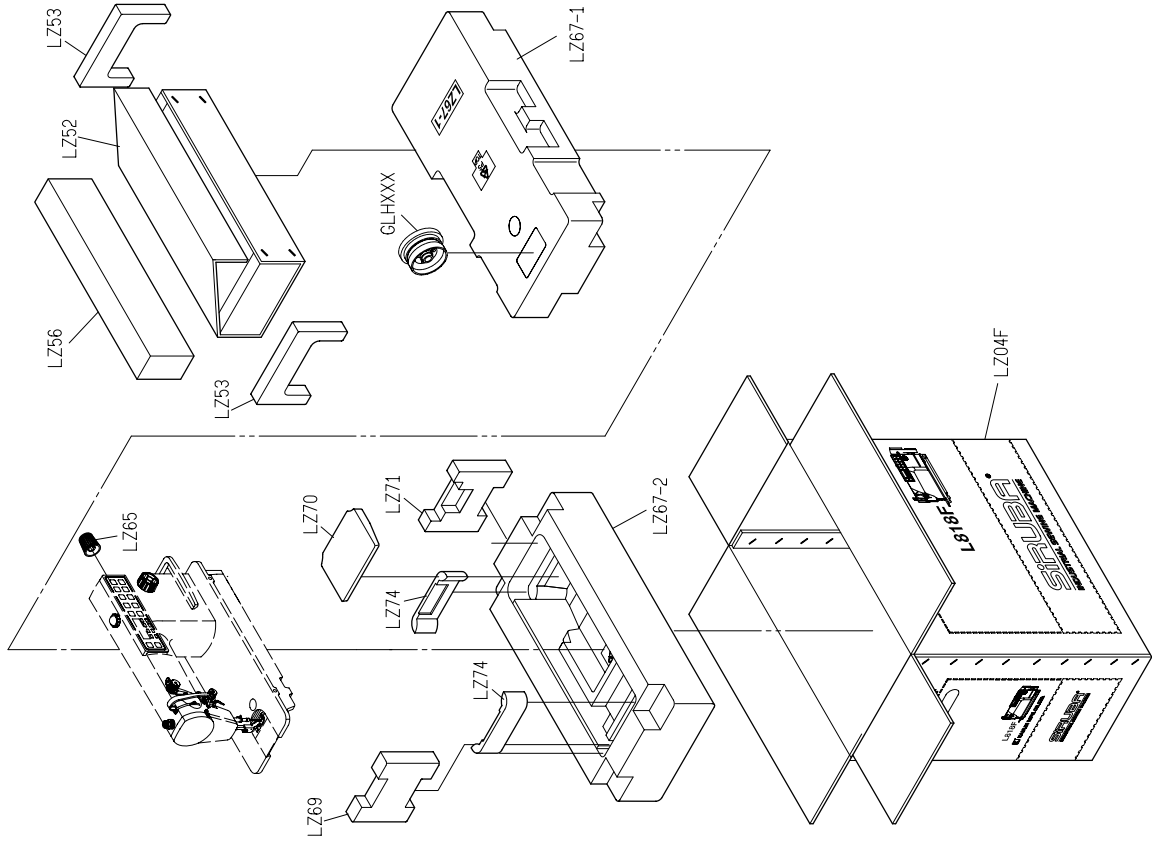
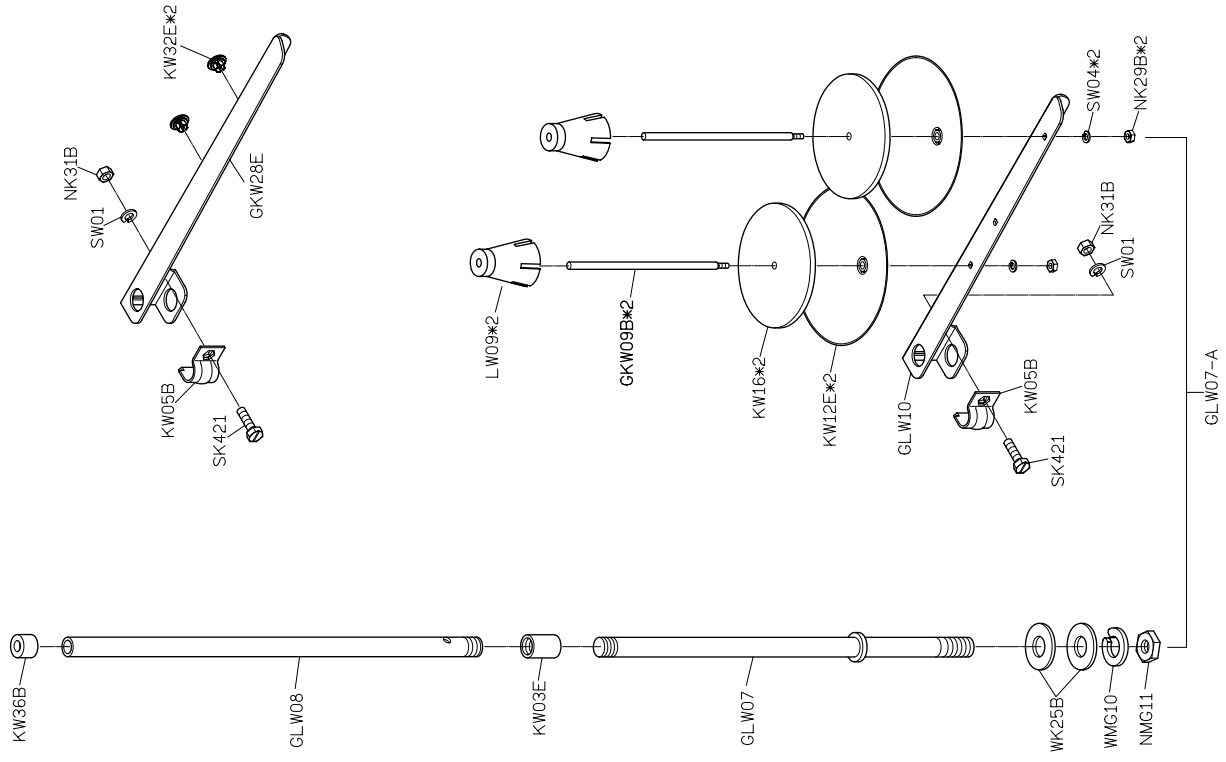

## LZ GRUP İÇİN PARÇA LİSTESİ

## THREAD STAND GRUP İÇİN PARÇA LİSTESİ



# L818F-BH1/BM1

高林股份有限公司 KAULIN MFG. CO., LTD.